

# StarBoard

## INTERACTIVE FLAT PANEL DISPLAY YL5 U



### Informative, Functional, Intuitive

With advanced touch technology, The StarBoard Interactive Flat Panel Display provides the latest infrared touch technology and with all the features you expect to meet the demands of active presentations and training environments.

Minimalist design with essential connectivity, front speakers, and IR technology makes it easy and intuitive to use. The large interactive surface offers a high-resolution image and delivers an excellent platform for your classroom to learn with creativity.

### Proven Touch Screen Technology

Experience the power of proven touchscreen technology with the StarBoard IIFPD. Choose between multi-finger touch, stylus pen, or pointer response for seamless writing, drawing, and navigation.

### Software

Equipped with StarBoard's Interactive Software, SBS Note, StarBoard Online. Effortlessly manage content, collaborate, and create an engaging learning or working environment.



**Android 14**

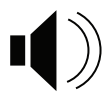

**Built in 2x20w  
Speakers**



**Ultra Slim Design**



**Compatibility Windows  
Mac OS & Linux**

# INTERACTIVE FLAT PANEL DISPLAY YL5 U

MODEL	YL5 U
Display Sizes	65" 75" 86"
Resolution	3840x2160 @60Hz
Active area (mm)	65": 1428.4x803.5 (64.53") 75": 1650.2x928.3 (74.52") 86": 1895.04x1065.9 (85.56")
Panel	IPS Panel (TN, TFT, VA opt.)
Glass	4mm tempered glass 7 on Mohs scale Anti-glare coating Anti-bacterial coating (opt.)
View angle	178°
Aspect Ratio	16:9
Brightness	500 cd/m2
Contrast	5000:1
Colors	10 Bit (1.07 Billion)
Resolutions supported	1024x768 / 1280x720 / 1280x960 1280x1024 / 1360x768 / 1440x900 1600x1200 / 1920x1080 / 3840x2160
Response time	<5 ms
WiFi	6 (IEEE 802.11ax)
Bluetooth	5.2
Software included	SBS Note, SB Software, StarBoard Online, iMagic, EShare (opt.)

## Input/Output connections

	Back input	Front input	Back output
HDMI 2.0	2	1	1
VGA	1		
USB-C	1	1 (65W)	
DP	1		
MIC	1		
USB 3.0	3	3	
TOUCH-USB	1	1	
RS232	1		
TF (microSD card)	1		
PC AUDIO	1		
EARPHONE			1
RJ45	1		1
OPS PORT	1		
SPDIF			1

## General

Weight (N.W)	65": 37.00 Kg 75": 50.00 Kg 86": 60.00 Kg
Weight (G.W)	65": 48.00 Kg 75": 65.00 Kg 86": 78.00 Kg
Machine dimensions	65": 1469x915x93 mm 75": 1700x1047x96.9 mm 86": 1942x1183x93.9 mm
Packaging Dimension	65": 1646x1074x240 mm 75": 1873x1204x240 mm 86": 2120x1353x240 mm
Life span	100.000 Hours
Warranty	3 years (opt. to extend)
Certificates	CE-RoHS, EnergyStar, EcoDesign

## Android specification

System	Android 14.0
GPU	G57
CPU	A76*2+A55*2
RAM	8G
Flash	EMMC 128G

## Touch specification

Working temp.	0°C – 40°C
Touch points	Up to 40 Points
Writing mode	Finger or pen
Touch Technology	Infrared with Zero Air Gap
Accuracy	<1 mm
Positioning Res.	4096x4096/16384 x 16384/32768x32768
Response time	<5ms
Cursor speed	>180 dot/Sec
Comm. Port	USB

## Power specification

Standby	< 0.5 W
Rated consumption	65":79W 75":89W 86":119W
Voltage range	AC (100-240) V-50/ 60Hz

OPS consumption is not included

# 65"

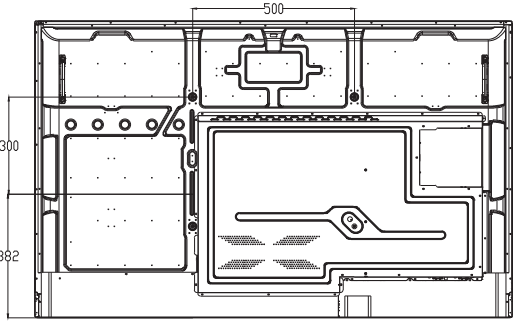
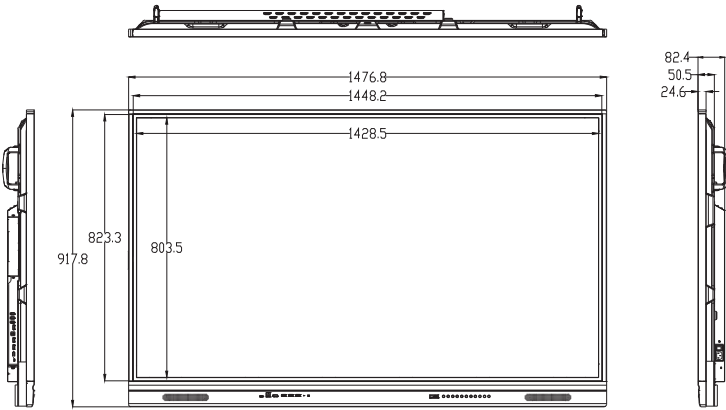

# 75"

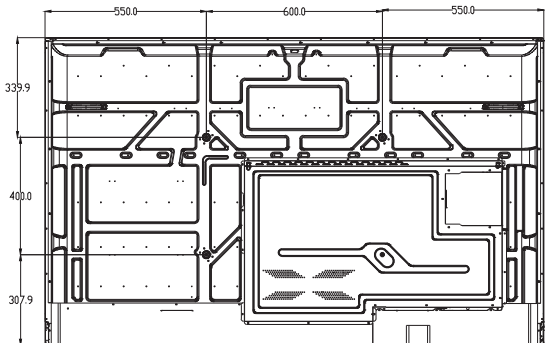
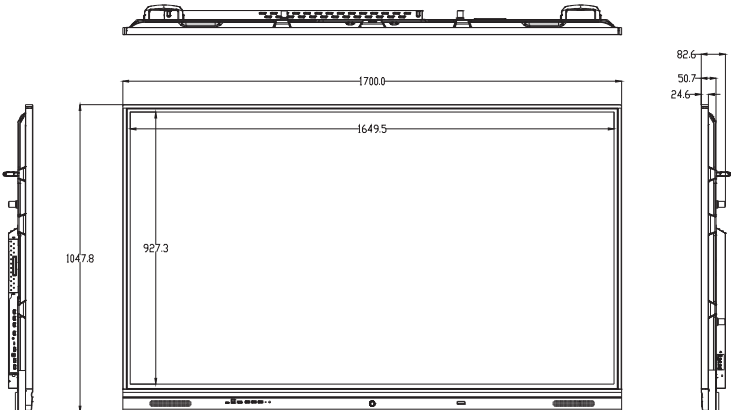

# 86"

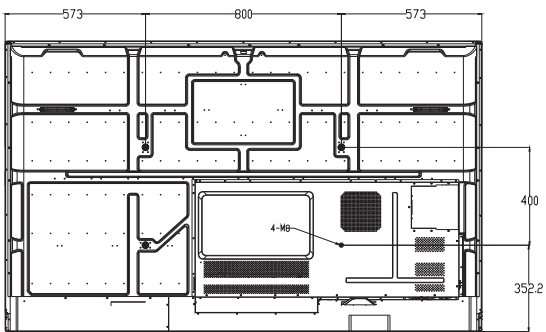
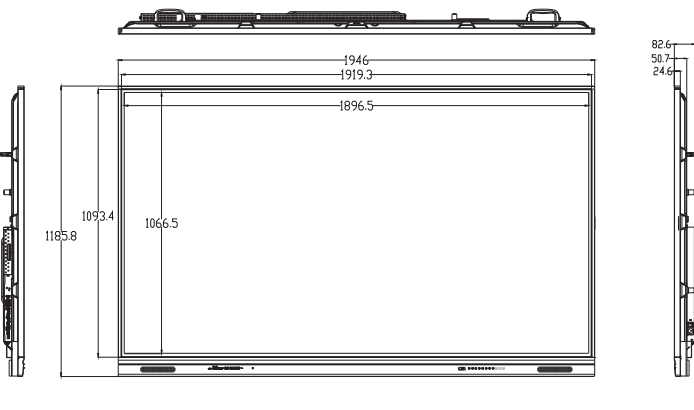

1. Accuracy of Information  
We make every effort to ensure the accuracy of the information contained on our website and in our product literature. However, due to continuous product improvement and variations in manufacturing, actual product specifications and features may differ slightly from those described.

2.Changes and Updates  
Product specifications, features, and availability are subject to change at any time without prior notice. We reserve the right to make changes to product designs, materials, and functionality to enhance performance and user experience.